

Catalog # :

Project :

Prepared By :

Date :



Scottsdale® Vertex™ - SCV Petroleum Canopy LED Luminaire



The Scottsdale® Vertex™ is the most feature-rich canopy fixture in the marketplace. Innovations such as combined optical distributions, multiple lumen packages, field serviceability and simple installation make this fixture the ideal canopy solution. Its exceptional design and performance are backed by LSI's best-in-class customer service.

SCOTTSDALE

Features & Specifications

Optical System

- Proprietary silicone refractor optics provide exceptional coverage and uniformity in Symmetrical or Combination Forward Throw distributions.
- State-of-the-art silicone optics deliver industry leading optical control with an integrated gasket to provide an IP65 rated sealed optical chamber in one component.
- Silicone optical material does not yellow or crack with age and provides a minimum light transmittance of 93%.
- Available in 5000K and 4000K (+/- 275K) color temperatures.
- Minimum CRI of 70.

Electrical

- High-performance driver features over-voltage, under-voltage, short-circuit and over temperature protection.
- 0-10V dimming (10% - 100%) standard.
- Standard Universal Voltage (120-277 Vac) Input 50/60 Hz or optional High Voltage (347-480 Vac).
- L80 Calculated Life: >100k Hours (See Lumen Maintenance on Page 2)
- Total harmonic distortion: <20%
- Operating temperature: -40°C to +50°C (-40°F to +122°F) when mounted to Steel/Aluminum surfaces for 10L, 13L, & 15L Lumen Packages, +45°C for 20L Lumen Package, and +40°C for 23L Lumen Package. If mounted to a non-metallic surface, reduce ambient by 5°C.
- Power factor: >0.90
- Input power stays constant over life.

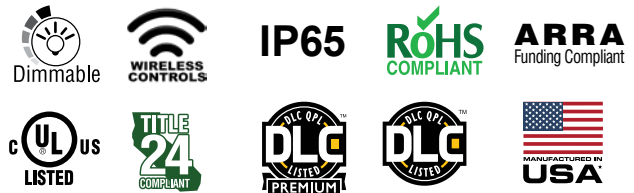

Dimensions

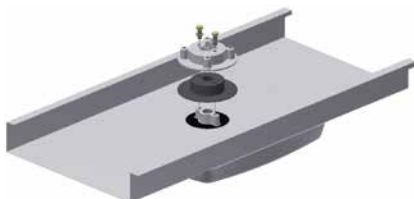
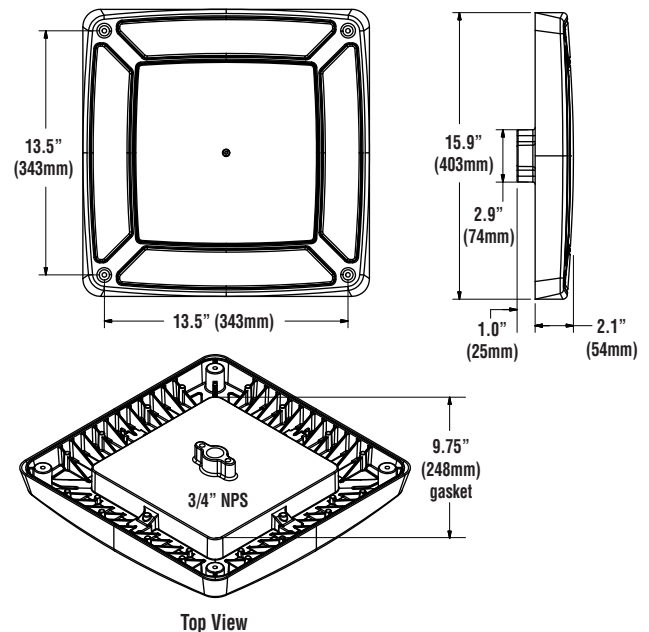

Locking Collar

Aluminum locking collar and gasket are included and required for complete seal and support of canopy deck.

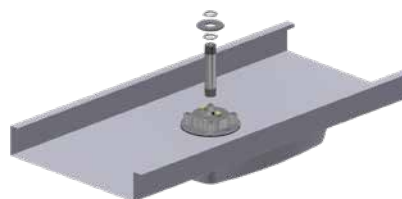

Conduit Stem Kit

Threaded 5" x 3/4" Conduit Stem and hardware are included to make retrofitting even easier by allowing the use of existing driver boxes and wiring connections on top of canopy.

* Assembled in USA by an American workforce of American and foreign parts using state-of-the-art equipment at our award-winning manufacturing facility in Ohio. Meets Buy American requirements within the ARRA.



Scottsdale® Vertex™ - SCV Petroleum Canopy LED Luminaire

Features & Specifications (Cont.)

Electrical (continued)

- Field replaceable surge protection device meets a minimum Category C Low operation (per ANSI/IEEE C62.41.2).
- High-efficacy LEDs are mounted to (4) circuit boards to maximize heat dissipation
- Components are fully encased in potting material for moisture resistance. Driver complies with FCC standards.
- A single fastener secures access door to driver and key components and provides quick & easy access to the electrical compartment for servicing.

Construction

- Rugged low-profile die-cast aluminum housing, optical unit, and driver cover.
- Ultra-slim 2" luminaire height and lightweight design effectively target a broad range of applications and allow for easy installations.
- Below canopy access to optical chamber and driver housing for serviceability.
- IP65 rated optical unit protects integral components from low pressure water jets from any direction.
- Luminaire is proudly manufactured in the U.S. of U.S. and imported parts.
- Fixtures are finished with LSI's DuraGrip® polyester powder coat finishing process. The DuraGrip finish withstands extreme weather changes without cracking or peeling. Other standard LSI finishes available. Consult factory.
- Shipping weight: 15 lbs in carton.

Hazardous Location

- Designed for lighter than air fuel applications. Product is suitable for Class 1 Division 2 with all lumen packages and distributions only when properly installed per LSI installation instructions.

T5 Temperature Classification – The surface temperature of this product will not rise above 100°C., within a 40°C ambient.

Gas Groups A, B, C, and D – Group A: Acetylene / Group B: Hydrogen / Group C: Propane and Ethylene / Group D: Benzene, Butane, Methane & Propane.

Controls

- Optional integral passive infrared motion and daylight sensor activates switching of luminaire light levels (see page 5 for details).
- LSI's AirLink™ wireless control system options reduce energy and maintenance costs while optimizing light quality 24/7 (see page 6 for details).

Installation

- Installs in a 12" or 16" deck pan.
- Four fasteners are provided with the fixture for using sing deck, metallic canopy substrates only when classified as suitable for use by installing professional otherwise suitable fasteners should be provided by others.
- Unit is designed to quickly retrofit into existing Scottsdale (4") hole.
- Aluminum locking collar and gasket are included and required for complete seal and support of canopy deck.
- Retrofit panels are available for existing Encores, Richmond, 2x2 Universal, and more (see accessories on page 3).

Warranty

- LSI LED Fixtures carry a 5-year warranty or 10-year warranty with registration for petroleum applications only (contact your LSI representative for details).

Listings

- Listed to UL 1598 and UL 8750.
- RoHS Compliant.
- State of California Title 24 Compliant with IMS or ALSC/ALSCS option.
- American Recovery and Reinvestment Act Funding Compliant.
- Lighting Facts Approved.
- IP65 Rated Optical Unit.
- DesignLights Consortium® (DLC) qualified product. Not all versions of this product may be DLC qualified. Please check the DLC Qualified Products List at www.designlights.org/QPL to confirm which versions are qualified.

Performance

| DELIVERED LUMENS* | | | | | |
|-------------------|------------------|----------|------------------|----------|---------|
| Lumens | 4000K | | 5000K | | Wattage |
| | Delivered Lumens | Efficacy | Delivered Lumens | Efficacy | |
| 10L | 10,218 | 156 | 10,306 | 156 | 66 |
| 13L | 12,793 | 153 | 12,933 | 153 | 84 |
| 15L | 15,209 | 150 | 15,411 | 150 | 103 |
| 20L | 20,083 | 153 | 20,141 | 155 | 130 |
| 23L (SC) | 22,652 | 149 | 23,150 | 152 | 153 |
| 23L (SCFT) | N/A | N/A | 24,361 | 127 | 192 |

*LED Chips are frequently updated therefore values are nominal.

| ELECTRICAL DATA - Current Draw (Amps)* | | | | | | |
|--|------|------|------|------|------|------|
| Lumens | 120V | 208V | 240V | 277V | 347V | 480V |
| 10L | 0.55 | 0.32 | 0.28 | 0.24 | 0.19 | 0.14 |
| 13L | 0.70 | 0.41 | 0.35 | 0.30 | 0.24 | 0.18 |
| 15L | 0.86 | 0.50 | 0.43 | 0.37 | 0.30 | 0.21 |
| 20L | 1.09 | 0.63 | 0.54 | 0.47 | 0.38 | 0.27 |
| 23L (SC) | 1.27 | 0.73 | 0.64 | 0.55 | 0.44 | 0.32 |
| 23L (SCFT) | 1.60 | 0.92 | 0.80 | 0.69 | 0.55 | 0.40 |

*Electrical data at 25C (77F). Actual wattage may differ by +/-10%.

| SC DISTRIBUTION RECOMMENDED LUMEN MAINTENANCE ¹ | | | | | |
|--|---------------------|-----------------------|-----------------------|-----------------------|------------------------|
| Ambient Temperature C | Lumen Multiplier | | | | |
| | 0 hrs. ² | 25K hrs. ² | 50K hrs. ² | 75K hrs. ³ | 100K hrs. ³ |
| 25 | 1.00 | 0.96 | 0.92 | 0.88 | 0.84 |
| 30 | 1.00 | 0.96 | 0.91 | 0.87 | 0.83 |
| 35 | 1.00 | 0.96 | 0.91 | 0.87 | 0.83 |
| 40 | 1.00 | 0.96 | 0.91 | 0.87 | 0.83 |
| 45 | 1.00 | 0.96 | 0.91 | 0.87 | 0.82 |

- 1 - Lumen maintenance values at 25°C are calculated per TM-21 based on LM-80 data and in-situ luminaire testing.
- 2 - In accordance with IESNA TM-21-11, Projected Values represent interpolated value based on time durations that are within six times (6X) the IESNA LM-80-08 total test duration (in hours) for the device under testing ((DUT) i.e. the packaged LED chip).
- 3 - In accordance with IESNA TM-21-11, Calculated Values represent time durations that exceed six times NA LM-80-08 total test duration (in hours) for the device under testing ((DUT) i.e. the packaged LED chip).

| SCFT DISTRIBUTION RECOMMENDED LUMEN MAINTENANCE ¹ | | | | | |
|--|---------------------|-----------------------|-----------------------|-----------------------|------------------------|
| Ambient Temperature C | Lumen Multiplier | | | | |
| | 0 hrs. ² | 25K hrs. ² | 50K hrs. ² | 75K hrs. ³ | 100K hrs. ³ |
| 25 | 1.00 | 1.00 | 1.00 | 0.99 | 0.99 |
| 30 | 1.00 | 1.00 | 0.99 | 0.99 | 0.99 |
| 35 | 1.00 | 1.00 | 0.99 | 0.99 | 0.99 |
| 40 | 1.00 | 1.00 | 0.99 | 0.99 | 0.99 |

- 1 - Lumen maintenance values at 25°C are calculated per TM-21 based on LM-80 data and in-situ luminaire testing.
- 2 - In accordance with IESNA TM-21-11, Projected Values represent interpolated value based on time durations that are within six times (6X) the IESNA LM-80-08 total test duration (in hours) for the device under testing ((DUT) i.e. the packaged LED chip).
- 3 - In accordance with IESNA TM-21-11, Calculated Values represent time durations that exceed six times NA LM-80-08 total test duration (in hours) for the device under testing ((DUT) i.e. the packaged LED chip).



Scottsdale® Vertex™ - SCV Petroleum Canopy LED Luminaire

Luminaire Ordering Guide

TYPICAL ORDER EXAMPLE: **SCV LED 13L SC UNV DIM 50 WHT IMS**

| Family / Size | LED Gen | Lumen Package* | Distribution | Voltage | Driver | Color Temperature | Finish | Controls |
|----------------------------------|---------|--|--|---|--------------------------------------|---------------------------------------|---|--------------|
| SCV - Petroleum Canopy Luminaire | LED | 10L - 10000 Lumens 13L - 13000 Lumens 15L - 15000 Lumens 20L - 20000 Lumens 23L - 23000 Lumens | SC - Standard Symmetric | UNV - 120-277V HV - 347-480V | DIM - Dims to 10% (0 to 10V dimming) | 40 - 4000K ² 50 - 5000K | WHT - White BLK - Black BRZ - Bronze Consult factory for additional paint finishes | Blank - NONE |
| | | 23L - 23000 Lumens | SCFT ¹ - Combination Standard Symmetric and Forward Throw | IMS ^{4,5} - Integral Motion & Daylight Sensor ALSC ³ - AirLink Synapse Wireless Control System ALSCS ³ - AirLink Synapse Wireless Control System with Sensor | | | | |

Accessory Ordering Information

| Description | Order Number |
|---|--------------|
| Retrofit Panel Kit - EC / ECTA / SCF to SCV, for 16" Deck Panel with larger openings ⁶ | 673425 |
| Retrofit Panel Kit - EC / ECTA / SCF to SCV, for 12" Deck Panel ⁷ | 676011 |
| Retrofit Panel Kit - RECU Richmond to SCV | 673426 |
| Retrofit Panel Kit - UNV Universal 2x2 to SCV | 673427 |
| Retrofit 2x2 Cover Panel Blank (no holes) | 357282 |
| Retrofit RIC Cover Panel Blank (no holes) | 354702 |
| 26" X 26" Beauty Plate Kit (with 4" Center hole) | 557193WHT |

| Description | Order Number |
|--|--------------|
| 26" X 32" Beauty Plate Kit (with 4" Center hole) | 564160WHT |
| Junction Box | 687461 |
| Kit - Hole Plugs and Sealant (enough for 25 retrofits) | 1320540 |
| Rectangular Top Plate Kit (includes top plate and sealant) | 678291WHT |
| Surface Mount Box | 673433 |
| IMS/PC Remote Configurator Tool | 584929 |

FOOTNOTES:

- 1 - Only available in 23L lumen package at 5000K color temperature. Listed under the DLC "Specialty" category.
- 2 - Consult factory on lead times for 4000K CCT.
- 3 - Consult factory for HV with AirLink Synapse Wireless Control System.
- 4 - IMS is a dual sensor (Daylight & Motion) which is field adjustable via IMS hand held remote configurator tool, which must be ordered separately.
- 5 - Not compatible with external dimming.
- 6 - Ideal for 9" to 12" openings.
- 7 - Ideal for 9" openings.



Scottsdale® Vertex™ - SCV Petroleum Canopy LED Luminaire

Retrofit Ordering Information

| To Retrofit Product | New Construction | Installation Method(s) to identify necessary accessories (Follow all installation instructions) | Part Number |
|---|---|--|-------------------------------|
| New Construction | New Construction | Use LSI supplied conduit stem with new LSI Junction Box. | 687461 |
| LSI Scottsdale | 4" Hole | Remove existing fixture and use LSI included conduit stem with existing Scottsdale ballast box. | |
| | | Remove existing Scottsdale and use LSI included conduit stem with new LSI Junction Box. | 687461 |
| LSI CRU/CRUS | 4" Hole (possibly with EC plates) | Remove existing fixture and use LSI included conduit stem with new LSI Junction Box. | 687461 |
| LSI Encore Top Access (ECTA) LSI SCF | 16" deck pan with 9" round hole | Remove existing fixture and use LSI included conduit stem with existing ECTA/SCF ballast box and Encore 16" Kit. | 673425 |
| | | Remove existing fixture and use LSI included conduit stem with LSI Junction Box and new Encore 16" Kit. | 673425 |
| | 12" deck pan with 9" round hole | Remove existing fixture and use LSI included conduit stem with existing ECTA/SCF ballast box and Encore 12" Kit. | 676011 |
| | | Remove existing fixture and use LSI included conduit stem with new LSI Junction Box and new Encore 12" Kit. | 687461 676011 |
| LSI Encore (bottom access) Cree 304 | 16" deck pan with 12" square hole | Remove existing fixture and use LSI included conduit stem with new LSI Junction Box and new Encore 16" Kit. | 687461 673425 |
| Cree CAN-228 30 LED | 16" deck pan with 7.375" x 11.375" rectangular hole | Remove existing fixture and use LSI included conduit stem with new LSI Junction Box and new Encore 16" Kit. | 687461 673425 |
| | 12" deck pan with 7.375" x 11.375" rectangular hole | Remove existing fixture and use LSI included conduit stem with new LSI Junction Box and new Encore 12" Kit. | 687461 676011 |
| LSI CRO2 LSI CRO3 LSI CRS | 5-hole pattern with 7" or 4" diameter (could be EC/ECTA retrofit of 9" or 12" hole) | Remove existing fixture and use LSI included conduit stem with existing CRO2/CRO3/CRS junction box. | |
| RECU Richmond Retrofit | Rectangular Richmond housing | Use new LSI RECU Accessory Kit. | 673426 |
| Total Replacement of: LSI Richmond Cree CAN-228 60LED Cree CAN-228 90LED | Rectangular hole 9.5" x 19.125" 7.375" x 16.125" 7.375" x 20.9375" | Remove existing fixture and use LSI included conduit stem with new LSI Rectangular Hole Kit (#TBD) and new LSI Junction Box. | 678291WHT 687461 |
| UNV (Universal 2x2) LSI Masters LSI Dakota Other similar 2x2 products | Surface mount 2x2 housing | Use new LSI UNV Accessory Kit. | 673427 |
| Remove Surface Mount Box | Conduit hole and possible discoloration of decking | Remove existing fixture and use LSI included conduit stem with new LSI Junction Box. [Possible need for beauty plates: 26" Beauty Plate (no holes) or 26" Beauty Plate with 4" center hole]. | 687461 357282 557193WHT |
| To install new Surface Mount Box | N/A | SURFACE MOUNT BOX KIT (AVAILABLE SOON) | 673433 |

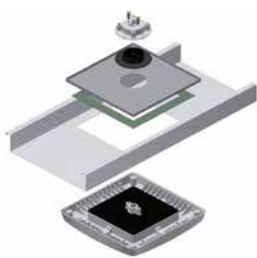

Encore 16" Accessory Kit
(673425)
Includes: top panel with sealant

Encore 12" Accessory Kit
(676011)
Includes: top panel with sealant



RECU Accessory Kit
(673426)
Includes cover panel, guide panel, tether clip and hardware



UNV Accessory Kit
(673427)
Includes mounting panel with auxiliary latch, 4 inner flange brackets and hardware to attach panel to fixture

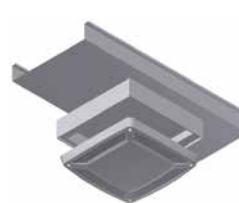

Surface Mount Box Kit
(673433)
Includes 2" deep housing with tether kit, tether bolt and mounting bolts.



Rectangular Hole Kit
(678291WHT)
Includes cover panel, top plate, hardware and sealant



Scottsdale® Vertex™ - SCV Petroleum Canopy LED Luminaire

Photometry

Luminaire photometry has been conducted by an NVLAP accredited testing laboratory in accordance with IESNA LM-79-08. As specified by IESNA LM-79-08 the entire luminaire is tested as the source resulting in a luminaire efficiency of 100%.

See <http://www.lsi-industries.com/products/led-lighting-solutions.aspx> for detailed photometric data.

SC

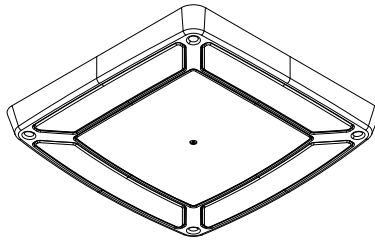
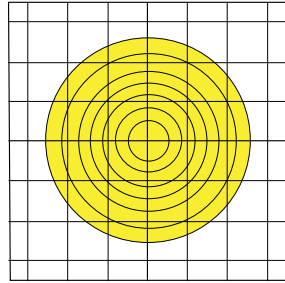

SCFT

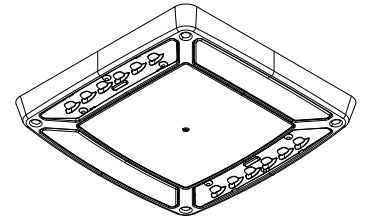
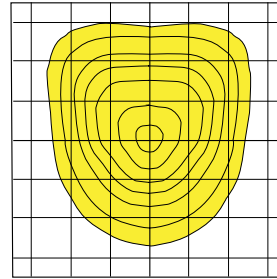

| CANOPY COMPARISON | | | | | | | | | |
|-------------------|---------------------|-----|----------------|---------------|--------------|--------------|----------------------|--------------|-----------------------|
| Canopy Layout | Fixture | QTY | Fixture Lumens | Fixture Watts | Lumens/Watts | Canopy/Watts | Canopy Watts/Sq. Ft. | *Canopy/Avg. | *Transition Area Avg. |
| 1 | SCV-LED-13L-SC-50 | 18 | 12,933 | 84.3 | 153 | 1,717 | 0.39 | 35.41 | 3.43 |
| 2 | SCV-LED-10L-SC-50 | 12 | 10,306 | 66.1 | 156 | 1,942 | 0.50 | 34.34 | 9.58 |
| | SCV-LED-23L-SCFT-50 | 6 | 24,361 | 191.5 | 127 | | | | |
| 3 | SCV-LED-13L-SC-50 | 12 | 12,933 | 84.3 | 153 | 2,161 | 0.56 | 39.43 | 9.70 |
| | SCV-LED-23L-SCFT-50 | 6 | 24,361 | 191.5 | 127 | | | | |
| 4 | SCV-LED-15L-SC-50 | 12 | 15,410 | 103.0 | 150 | 2,385 | 0.62 | 44.23 | 9.80 |
| | SCV-LED-23L-SCFT-50 | 6 | 24,361 | 191.5 | 127 | | | | |
| 5 | SCV-LED-20L-SC-50 | 12 | 20,141 | 130.3 | 155 | 2,713 | 0.70 | 53.38 | 10.03 |
| | SCV-LED-23L-SCFT-50 | 6 | 24,361 | 191.5 | 127 | | | | |
| 6 | SCV-LED-23L-SC-50 | 12 | 23,150 | 152.5 | 152 | 2,979 | 0.77 | 59.22 | 10.16 |
| | SCV-LED-23L-SCFT-50 | 6 | 24,361 | 191.5 | 127 | | | | |

*Initial foot-candle values at grade.

(18) 13L Symmetrical Fixtures

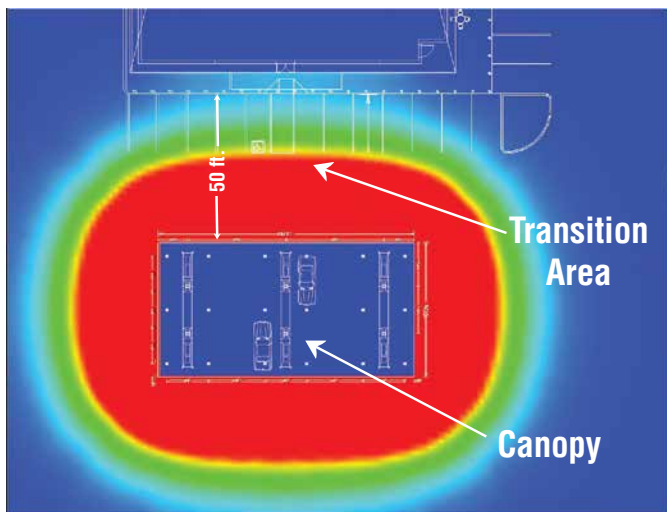

(12) Symmetrical AND (6) Combo FT Fixtures

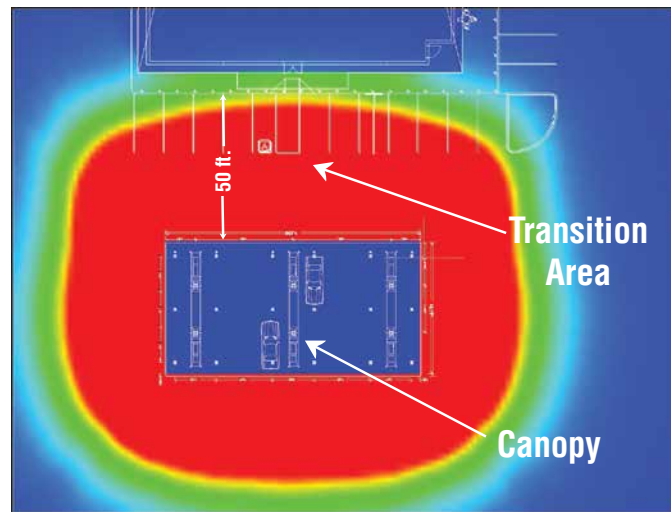



Scottsdale® Vertex™ - SCV Petroleum Canopy LED Luminaire

Controls

Occupancy Sensor / Daylight Sensor (IMS)

Optional integral passive infrared motion and daylight sensor activates switching of luminaire light levels. Standard Factory settings: High level light is activated and increased to full bright upon detection of motion. Low light level (30% maximum drive current) is activated when target zone is absent of motion activity for ~5 minutes. See coverage diagram for detection cone. Optional configurator tool allows for easy and safe programming of each luminaire from the ground level.

IMS/PC Remote Configurator Tool

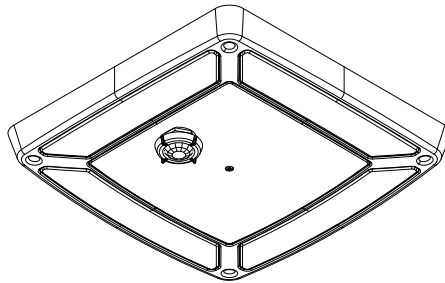

IMS Coverage Diagram

SIDE VIEW

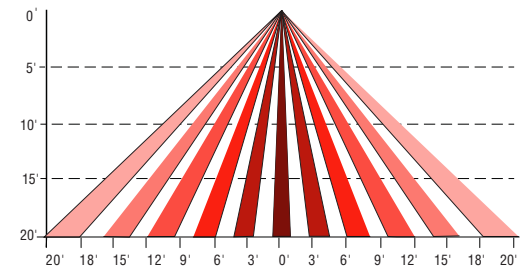

TOP VIEW

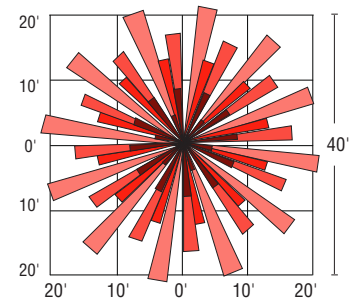

AirLink™
enabled by Synapse®

Wireless Lighting Controller (ALSC/ALSCS)

The AirLink integrated controller is a California Title 24 compliant lighting controller that provides real-time light monitoring and control with utility-grade power monitoring. It includes a 24V sensor input and power supply to connect up to two (2) sensors into the outdoor AirLink wireless lighting system.

Features

- 2% Utility Grade Power Monitoring
- Up to 80% Savings through smart dimming
- True On/Off functionality via switched relay
- Seamlessly integrates into the outdoor AirLink wireless lighting control solution & Self-healing Mesh Networking
- Relay closes on power loss
- Supports a wide range of LED drivers and fixtures
- Class 1 / Class 2 0-10V Dimming Control
- Direct Connect up to two (2) to 24V Occupancy Sensors and Photocells (consult sales for compatible list)
- Secure, over-the-air upgrades to support future enhancements
- Excellent RF Range — 1,000ft LoS between controllers
- Lights default to on for safety

Specifications

Regulatory Approvals

- FCC, IC, CE certified
- cULus Listed
- California Title 24 compliant

Power and Performance

- Operating environmental: -40°F to 131°F (-40°C to 55°C)
- Input power: 100-277 VAC +/- 10% (Max 305V) 47/64 Hz
- Switched output: Default ON; Zero Cross Switching
- Load rating: 5A @ 100V to 277V (+/- 10%)
- Dimming: 0-10V control; Output: Class 1/2 - 20mA Source Max / 50mA Sink Max
- Power monitoring: Utility grade - 2% accuracy
- Sensors inputs: 0-10V (photocell sensors), 0-24V (all other sensors); Sensor power supply: 24VDC @ 50mA

Other

- Radio: SNAP 2.4 GHz; 802.15.4; +20 dBm Transmit Power; -105 dBm Receive Sensitivity
- Warranty: 5 years



Sales
controls.sales@lsi-industries.com



Support
controls.support@lsi-industries.com
1 (800) 436-7800 (support, option 8)



More information
For more information on AirLink, visit our website at www.lsi-airlink.com/airlink